



Community Solar Energy Pilot Program Application Form

Section A: Application Form Requirements, Instructions, Terms and Conditions

The following Application Form is intended only for entities submitting a community solar project for consideration by the New Jersey Board of Public Utilities ("Board" or "BPU"). Projects selected by the Board will be approved for participation in the Community Solar Energy Pilot Program, pursuant to the rules at N.J.A.C. 14:8-9.

This Application Form is valid only for the following Program Year and Application Period:

Program Year 1, Application Period 1

Application Period Opens: April 9, 2019 at 9:00 A.M.

Application Period Closes: September 9, 2019 at 5:00 P.M.

I. Minimum Qualification Requirements

The Community Solar Energy Pilot Program is open to projects that meet the following minimum requirements, and the full requirements defined in N.J.A.C. 14:8-9 (available for reference at the following link: [http://njcleanenergy.com/files/file/R_2019%20d_021%20\(51%20N_J_R_%20232\(a\)\).pdf](http://njcleanenergy.com/files/file/R_2019%20d_021%20(51%20N_J_R_%20232(a)).pdf)).

1. The proposed community solar project must be located in the electric service territory of an Electric Distribution Company ("EDC") in the State of New Jersey.
2. Existing solar projects may not apply to requalify as a community solar project. An existing solar project, as defined in N.J.A.C. 14:8-9.2, means a solar project having begun operation and/or been approved by the Board for connection to the distribution system prior to February 19, 2019. Projects having received a subsection (t) conditional certification from the Board prior to February 19, 2019 should refer to section B. XIII. Special Authorizations and Exemptions for additional information.
3. The Board will not consider Applications for EDCs to develop, own, or operate community solar project(s).
4. The Board will not consider Applications for projects sited on preserved farmland, as defined in N.J.A.C. 14:8-9.2.
5. The Board will not consider Applications for projects exceeding the capacity limit for individual community solar projects, set at 5 MW as defined in N.J.A.C. 14:8-9.4(g).

II. Instructions for Completing the Community Solar Energy Pilot Program Application Form

1. Each solar project applying to participate in the Community Solar Energy Pilot Program requires the submission of an individual Application Form. Do not apply for more than one (1) project per Application Form. There is no limit to the number of Application Forms that can be submitted by any one Applicant (see the definition of an "Applicant" in section A. III. Terms and Conditions).



2. Complete sections B and C, and Appendix A in full. All questions are required to be answered, unless explicitly marked as optional. All attachments are required, unless explicitly marked as optional. All attachments must be attached to the end of the Application Form, therefore forming a complete application package. Note that attachments marked as optional will be considered if included, but their absence will not penalize an Application.
3. Original signatures on all forms and certifications of this Application Form are required. The certifications contained in section C must be notarized.
4. Specific exemptions are identified throughout the Application Form which apply only if: 1) the Applicant is a government entity (municipal, county, or state), AND 2) the community solar developer will be selected by the Applicant via a Request for Proposals (“RFP”), Request for Quotations (“RFQ”), or other bidding process. If this is the case, the Applicant must include a letter describing the proposed bidding process, and the Applicant should complete all sections of the Application Form based on the project as it will be designed in the bidding process. The Applicant must further commit to issuing said RFP, RFQ, or other bidding process within 90 days of the proposed project being approved by the Board for participation in the Community Solar Energy Pilot Program (see section B. XIII. Special Authorizations and Exemptions).

III. Terms and Conditions

General Terms and Conditions

1. The “Applicant” is defined as the entity that submits the Community Solar Energy Pilot Program Application Form (for example, an Applicant may be a project developer, project owner, project operator, property owner, contractor, installer, or agent thereof).
2. Prior to completing the Application Form, the Applicant must carefully review the rules at N.J.A.C. 14:8-9, and any other rules, regulations, and codes applicable to the design, construction, and operation of a community solar project in New Jersey. All Applications must be in compliance with all local, state and federal rules, regulations and laws. Furthermore, submission of an Application Form does not obviate the need for compliance with all applicable local, state, and federal laws and regulations at any time during the design, construction, operation, and decommissioning of a community solar project including, but not limited to, regulations by commissions such as the New Jersey Highlands Council and the New Jersey Pinelands Commission.
3. By submitting an Application, the Applicant acknowledges notice on behalf of all project participants that the information included in the Application is subject to disclosure under the Open Public Records Act, N.J.S.A. 47:1A-1 et seq. Aggregated information may be used by the Board and/or other state, federal, county, regional or local agencies in reports and evaluations, and the geographic location may be used to update Geographic Information System (“GIS”) mapping. Applicants may identify sensitive and trade secret information that they wish to keep confidential by submitting them in accordance with the confidentiality procedures set forth in



- N.J.A.C. 14:1-12.3. Furthermore, the Applicant understands that the list of approved community solar projects will be published on the Board of Public Utilities website.
4. Amendments or supplements to the Community Solar Energy Pilot Program Application Form will be made available via the New Jersey Clean Energy Program ("NJCEP") website at www.njcleanenergy.com. This Application Form may be modified for future Application Periods at any time without prior notification.

Evaluation of Applications and Approval of Projects

5. Only Applications that are administratively complete by the close of the Application Period will be considered for participation in the Community Solar Energy Pilot Program during that Program Year. An application will be deemed administratively complete if: 1) All questions are completed, except those explicitly marked as optional, 2) All required attachments are included (see Appendix B for a checklist of required attachments), and 3) All required signatures are included. Applicants will be notified if an Application is deemed administratively incomplete. An incomplete Application may be amended and resubmitted during the following Application Period without advantage or disadvantage.
6. The Applicant may be required to supplement the information provided in the Application Form upon request from the Board or Board Staff.
7. Following the close of the Application Period, each Application will be reviewed and evaluated by a dedicated Evaluation Committee.
8. In reviewing each application, Board Staff may consult with the New Jersey Department of Environmental Protection ("NJDEP"), the New Jersey Department of Agriculture, or other state agencies and consultants as are relevant to the Application. Any information marked and submitted as confidential will be treated as such by the receiving agency, and used for the sole purpose of evaluation.
9. The criteria for evaluation of Applications are presented in Appendix C (Evaluation Criteria). Projects must score a minimum 30 points total in order to be considered for participation in the Community Solar Energy Pilot Program. Projects that score above 30 points will be presented to the Board for approval for participation in the Community Solar Energy Pilot Program in order, starting with the highest-scoring project and proceeding to the lowest-scoring project, and until the allocated program capacity for that Program Year is filled.
The allocated program capacity for Program Year 1 is 75 MW. At least 40% of program capacity (i.e. at least 30 MW) will be allocated to LMI projects.
10. Board Staff may reject Applications that are incomplete at the close of the Application Period, that are not in compliance with the rules and regulations established in N.J.A.C. 14:8-9, or that do not meet a minimum standard for selection, as set forth in this Application Form.



Milestones and Follow-Up for Approved Projects

11. Should the proposed community solar project be approved by the Board for participation in the Community Solar Energy Pilot Program, such approval will be contingent on the project being constructed and operated as was proposed in its Application.

Furthermore, pursuant to the rules at N.J.A.C. 14:8-9.3(c), approved projects are expected to begin construction within 6 months of their approval by the Board, and are expected to become fully operational within 12 months of their approval by the Board. Extensions may be granted by Board Staff at its discretion, based on its assessment of the specific circumstances of each project approved.

In order to monitor compliance, approved projects will be required to submit updates to the Board:

- a. Prior to the beginning of construction, the Applicant must provide evidence that commitments in the following categories have been met: project location, community and environmental justice engagement, other benefits.
- b. Prior to applying for permission to operate ("PTO"), the Applicant must provide evidence that commitments in the following categories have been met: siting (other than location), all permits received.
- c. Prior to applying to the EDC for allocation of bill credits, the Applicant must provide evidence that commitments in the following categories have been met: product offering, subscriber type, geographic limit within EDC service territory.

If the approved project fails to be completed as proposed in the Application, and the Applicant fails to remediate the failure or provide an equivalent modification within a reasonable timeframe, the project may be penalized up to and including a withdrawal of the permission to operate in the Community Solar Energy Pilot Program.

Special Considerations for Project Siting

12. Unless the proposed community solar facility is located on a rooftop, parking lot, or parking structure, the Applicant must meet with the NJDEP's Office of Permit Coordination and Environmental Review ("PCER") to determine what permits may be required and to identify other potential issues. More information is available at: <http://www.nj.gov/dep/pcer>. The Applicant must have completed the NJDEP Permit Readiness Checklist and submitted said Checklist to NJDEP PCER prior to submitting the Application to the Board (see section B. VIII. Permits). The Permit Readiness Checklist is available at the following link: <https://www.nj.gov/dep/pcer/introcklist.htm>.
13. Special attention should be paid when siting a project on a landfill, a brownfield, or an area of historic fill. For reference, NJDEP's *Guidance for Installation of Solar Renewable Energy Systems on Landfills in New Jersey* can be found at the following link: <https://www.nj.gov/dep/dshw/swp/solarguidance.pdf>.
14. The Applicant should review the environmental compliance history at the proposed site and the various operations that were conducted there. Satisfaction of all outstanding NJDEP regulatory



compliance obligations, if applicable, will be required prior to applying for permission to operate. The Applicant should identify any outstanding compliance and enforcement issues associated with the property on which the proposed project is to be sited and resolve them accordingly before submitting the Post Construction NJDEP Compliance Form, if applicable.

15. If the proposed project is sited on Green Acres preserved open space, as defined in N.J.A.C. 14:8-9.2, or on land owned by NJDEP, the Applicant must receive special approval for the project from NJDEP prior to submitting the Application to the Board, and attach proof of approval to their application package (see section B. VII. Community Solar Facility Siting).

Submitting an Application

Applications must adhere to all of the following instructions for submission. Applications must be received no later than 5:00 P.M. on the date of the close of the Application Period in order to be considered.

Mail or hand-deliver the original complete Application package plus three copies of the complete Application package to:

New Jersey Board of Public Utilities
44 South Clinton Avenue, 7th Floor
Post Office Box 350
Trenton, New Jersey 08625-0350
Attn: Office of Clean Energy
Community Solar Energy Pilot Program Application Package

In addition, submit an electronic version of the complete Application package to both of the following email addresses: communitysolar@njcleanenergy.com and board.secretary@bpu.nj.gov.

Questions and Further Information

Please address all questions pertaining to the Application Form to communitysolar@njcleanenergy.com.

Additional guidance and Frequently Asked Questions will be available on the NJCEP website at: <http://njcleanenergy.com/renewable-energy/programs/community-solar>.



Section B: Community Solar Energy Project Description

Instructions: Section B must be completed in its entirety. Any attachments should be placed at the end of the Application package.

I. Applicant Contact Information

Applicant Company/Entity Name: IP SOLAR NJ, LLC
First Name: Debra Last Name: Einhorn
Daytime Phone: [REDACTED] Email: [REDACTED]
Applicant Mailing Address: 1750 Cedarbridge Avenue, SU
Municipality: Lakewood County: Ocean Zip Code: 08701

- Applicant is: Community Solar Project Owner Community Solar Developer/Facility Installer
 Property/Site Owner Subscriber Organization
 Agent (if agent, what role is represented) Manager of the roof of the property

II. Community Solar Project Owner

Project Owner Company/Entity Name (complete if known): NextGrid Inc
First Name: George Last Name: St Onge
Daytime Phone: [REDACTED] Email: [REDACTED]
Mailing Address: PO Box 7775 #73069
Municipality: San Francisco County: San Francisco Zip Code: 94120

III. Community Solar Developer

This section, "Community Solar Developer," is optional if: 1) the Applicant is a government entity (municipal, county, or state), AND 2) the community solar developer will be selected by the Applicant via a RFP, RFQ, or other bidding process. In all other cases, this section is required.

Developer Company Name (optional, complete if applicable): NextGrid Inc
First Name: George Last Name: St Onge
Daytime Phone: [REDACTED] Email: [REDACTED]
Mailing Address: PO Box 7775 #73069
Municipality: San Francisco County: San Francisco Zip Code: 94120

- The proposed community solar project will be primarily built by:
 the Developer a contracted engineering, procurement and construction ("EPC") company



If the proposed community solar project will be primarily built by a contracted EPC company, complete the following (optional, complete if known):

If the EPC company information is left blank and the proposed project is approved by the Board for participation in the Community Solar Energy Pilot Program, the Applicant must inform the Board of the information below once the EPC company becomes known.

EPC Company Name (optional, complete if applicable): _____
First Name: _____ Last Name: _____
Daytime Phone: _____ Email: _____
Mailing Address: _____
Municipality: _____ County: _____ Zip Code: _____

IV. Property/Site Owner Information

Property Owner Company/Entity Name: IP SOLAR NJ, LLC
First Name: Debra Last Name: Einhorn
Daytime Phone: [redacted] Email: [redacted]
Applicant Mailing Address: 1750 Cedarbridge Avenue, Sui 3
Municipality: Lakewood County: Ocean Zip Code: 08701

V. Community Solar Subscriber Organization (optional, complete if known)

If this section, "Community Solar Subscriber Organization," is left blank and the proposed project is approved by the Board for participation in the Community Solar Energy Pilot Program, the Applicant must inform the Board of the information below once the Subscriber Organization becomes known.

Subscriber Organization Company/Entity Name (optional, complete if applicable): _____
First Name: _____ Last Name: _____
Daytime Phone: _____ Email: _____
Mailing Address: _____
Municipality: _____ County: _____ Zip Code: _____

VI. Proposed Community Solar Facility Characteristics

Community Solar Facility Size (as denominated on the PV panels):
.5 MW AC .642 MW DC
Community Solar Facility Location (Address): 125 Kenyon Dr
Municipality: Lakewood County: Ocean Zip Code: 08701
Name of Property (optional, complete if applicable): Kenyon 125, LLC
Property Block and Lot Number(s): 1603 / 2.01



Community Solar Site Coordinates: -74.179674 Longitude 40.078569 Latitude

Total Acreage of Property Block and Lots: 3 acres
Total Acreage of Community Solar Facility: 1.5 acres

Attach a delineated map of the portion of the property on which the community solar facility will be located. In the electronic submission, two copies of the delineated map should be provided: 1) as a PDF document, and 2) as a design plan in drawing file format (.dwg) or as a shapefile (.shp), in order to facilitate integration with Geographic Information System (GIS) software.

EDC electric service territory in which the proposed community solar facility is located: (select one)

- Atlantic City Electric
- Jersey Central Power & Light
- Public Service Electric & Gas
- Rockland Electric Co.

Estimated date of project completion* (The Applicant should provide a good faith estimate of the date of project completion; however, this data is being collected for informational purposes only.): June (month) 2020 (year)

Project completion is defined pursuant to the definition at N.J.A.C. 14:8-9.3 as being fully operational, up to and including having subscribers receive bill credits for their subscription to the project.

The proposed community solar facility is an existing project* Yes No

If "Yes," the Application will not be considered by the Board. See section B. XIII. for special provisions for projects having received a subsection (t) conditional certification from the Board prior to February 19, 2019.

*Existing project is defined in N.J.A.C. 14:8-9.2 as a solar project having begun operation and/or been approved by the Board for connection to the distribution system prior to February 19, 2019.

VII. Community Solar Facility Siting

1. The proposed community solar project has site control* Yes No

If "Yes," attach proof of site control.

If "No," the Application will be deemed incomplete.

*Site control is defined as property ownership or option to purchase, signed lease or option to lease, or signed contract for use as a community solar site or option to contract for use as a community solar site.

2. The proposed community solar facility is located, in part or in whole, on preserved farmland* Yes No

If "Yes," the Application will not be considered by the Board.



*Preserved farmland is defined in N.J.A.C. 14:8-9.2 as land from which a permanent development easement was conveyed and a deed of easement was recorded with the county clerk's office pursuant to N.J.S.A. 4:1C-11 et seq.; land subject to a farmland preservation program agreement recorded with the county clerk's office pursuant to N.J.S.A. 4:1C-24; land from which development potential has been transferred pursuant to N.J.S.A. 40:55D-113 et seq. or N.J.S.A. 40:55D-137 et seq.; or land conveyed or dedicated by agricultural restriction pursuant to N.J.S.A. 40:55D-39.1.

- 3. The proposed community solar facility is located, in part or in whole, on Green Acres preserved open space* or on land owned by the New Jersey Department of Environmental Protection (NJDEP) Yes No

If "Yes," the Applicant must attach special authorization from NJDEP for the site to host a community solar facility. The Board will not consider Applications for projects located, in part or in whole, on Green Acres preserved open space or on land owned by NJDEP, unless the Applicant has received special authorization from NJDEP and includes proof of such special authorization in the Application package.

*Green Acres preserved open space is defined in N.J.A.C. 14:8-9.2 as land classified as either "funded parkland" or "unfunded parkland" under N.J.A.C. 7:36, or land purchased by the State with "Green Acres funding" (as defined at N.J.A.C. 7:36).

- 4. The proposed community solar facility is located, in part or in whole, on land located in the New Jersey Highlands Planning Area or Preservation Area Yes No

- 5. The proposed community solar facility is located, in part or in whole, on land located in the New Jersey Pinelands Yes No

- 6. The proposed community solar facility is located, in part or in whole, on land that has been actively devoted to agricultural or horticultural use and that is/has been valued, assessed, and taxed pursuant to the "Farmland Assessment Act of 1964," P.L. 1964, c.48 (C. 54:4-23.1 et seq.) at any time within the ten year period prior to the date of submission of the Application Yes No

- 7. The proposed community solar facility is located, in part or in whole, on a landfill Yes No
If "Yes," provide the name of the landfill, as identified in NJDEP's database of New Jersey landfills, available at www.nj.gov/dep/dshw/lrm/landfill.htm: _____

- 8. The proposed community solar facility is located, in part or in whole, on a brownfield Yes No
If "Yes," has a final remediation document been issued for the property? Yes No



If "Yes," attach a copy of the Response Action Outcome ("RAO") issued by the LSRP or the No Further Action ("NFA") letter issued by NJDEP.

9. The proposed community solar facility is located, in part or in whole, on an area of historic fill Yes No

If "Yes," have the remedial investigation requirements pursuant to the Technical Requirements for Site Remediation, N.J.A.C. 7:26E-4.7 been implemented? Yes No

Has the remediation of the historic fill been completed pursuant to the Technical Requirements for Site Remediation, N.J.A.C. 7:26E-5.4? Yes No

If the remediation of the historic fill has been completed, attach a copy of the Response Action Outcome ("RAO") issued by a Licensed Site Remediation Professional ("LSRP") or the No Further Action ("NFA") letter issued by NJDEP.

10. The proposed community solar facility is located on a parking lot Yes No

11. The proposed community solar facility is located on a parking deck Yes No

12. The proposed community solar facility is located on a rooftop Yes No

13. The proposed community solar facility is located on a canopy over an impervious surface (e.g. walkway) Yes No

14. The proposed community solar facility is located on the property of an affordable housing building or complex Yes No

15. The proposed community solar facility is located on a water reservoir or other water body ("floating solar") Yes No

16. The proposed community solar facility is located on an area designated in need of redevelopment Yes No

If "Yes," attach proof of the designation of the area as being in need of redevelopment from a municipal, county, or state entity.

17. The proposed community solar facility is located on land or a building that is preserved by a municipal, county, state, or federal entity Yes No

If "Yes," attach proof of the designation of the area as "preserved" from a municipal, county, or state entity.

18. The proposed community solar facility is located, in part or in whole, on forested lands Yes No



Construction of the proposed community solar facility will require cutting down one or more trees Yes No

If "Yes," estimated number of trees required to be cut for construction: _____

19. The proposed community solar facility is located on land or a building owned or controlled by a government entity, including, but not limited to, a municipal, county, state, or federal entity Yes No

20. Are there any use restrictions at the site? Yes No
If "Yes," explain the use restriction below and provide documentation that the proposed community solar project is not prohibited.

Will the use restriction be required to be modified? Yes No
If "Yes," explain the modification below.

21. The proposed community solar facility has been specifically designed or planned to preserve or enhance the site (e.g. landscaping, land enhancements, pollination support, stormwater management, soil conservation, etc.) Yes No
If "Yes," explain below, and provide any additional documentation in an attachment.

NextGrid has committed to \$50,000 of roofing upgrades at the site. An energy audit will be conducted to increase efficiency and reduce consumption of the building.

VIII. Permits

1. The Applicant has completed NJDEP Permit Readiness Checklist, and submitted it to NJDEP's PCER Yes No
If "Yes," attach a copy of the completed Permit Readiness Checklist as it was submitted to NJDEP PCER.



If “No,” the Application will be deemed incomplete. Exception: Applications for community solar projects located on a rooftop, parking lot, or parking structure are exempt from this requirement.

2. The Applicant has met with NJDEP’s PCER Yes No

If “Yes,” attach proof of a meeting with NJDEP PCER.

If “No,” the Application will be deemed incomplete. Exception: Applications for community solar projects located on a rooftop, parking lot, or parking structure are exempt from this requirement.

3. Please list all permits, approvals, or other authorizations that will be needed for the construction and operation of the proposed community solar facility pursuant to local, state and federal laws and regulations. Include permits that have already been received, have been applied for, and that will need to be applied for. The Applicant may extend this table by attaching additional pages if necessary. These include:

- a. Permits, approvals, or other authorizations from NJDEP (i.e. Land Use, Air Quality, New Jersey Pollutant Discharge Elimination System “NJPDES”, etc.) for the property.
- b. Permits, approvals, or other authorizations from NJDEP (i.e. Land Use, Air Quality, NJPDES, etc.) directly related to the installation and operation of a solar facility on this property.
- c. Permits, approvals, or other authorizations other than those from NJDEP for the development, construction, or operation of the community solar facility (including local zoning and other local and state permits)

An Application that does not list all permits, approvals, or other authorizations that will be needed for the construction and operation of the proposed community solar facility will be deemed incomplete.

If a permit has been received, attach a copy of the permit.

Permit Name & Description	Permitting Agency/Entity	Date Permit Applied for <i>(if applicable)</i> / Date Permit Received <i>(if applicable)</i>
Interconnection Agreement	JCP&L (Utility)	10/2019
Building Permit	Lakewood Township	2/2020



4. The Applicant has consulted the hosting capacity map of the relevant EDC and determined that, based on the capacity hosting map as published at the date of submission of the Application, there is sufficient capacity available at the proposed location to build the proposed community solar facility Yes No
 If "Yes," include a screenshot of the capacity hosting map at the proposed location, showing the available capacity.
 If "No," the Application will be deemed incomplete.

IX. Community Solar Subscriptions and Subscribers

1. Estimated or Anticipated Number of Subscribers (please provide a good faith estimate or range):
47
2. Estimated or Anticipated Breakdown of Subscribers (please provide a good faith estimate or range of the kWh of project allocated to each category):
 Residential: 45 Commercial: 2
 Industrial: _____ Other: _____ (define "other": _____)
3. The proposed community solar project is an LMI project* Yes No
 *An LMI project is defined pursuant to N.J.A.C. 14:8-9 as a community solar project in which a minimum 51 percent of project capacity is subscribed by LMI subscribers.
4. The proposed community solar project will allocate at least 51% of project capacity to residential customers Yes No
5. The proposed community solar project is being developed in partnership with an affordable housing provider: Yes No
 If "Yes," attach a letter of support from the affordable housing provider.
6. An affordable housing provider is seeking to qualify as an LMI subscriber for the purposes of the community solar project Yes No
 If "Yes," estimated or anticipated percentage of the project capacity for the affordable housing provider's subscription (provide an estimate or range): _____

If "Yes," what specific, substantial, identifiable, and quantifiable long-term benefits from the community solar subscription are being passed through to their residents/tenants?



Additionally, the affordable housing provider must attach a signed affidavit that the specific, substantial, identifiable, and quantifiable long-term benefits from the community solar subscription will be passed through to their residents/tenants.

7. This project uses an anchor subscriber (optional) Yes No
If "Yes," name of the anchor subscriber (optional): _____
Estimated or anticipated percentage or range of the project capacity for the anchor subscriber's subscription: _____

8. Is there any expectation that the account holder of a master meter will subscribe to the community solar project on behalf of its tenants? Yes No
If "Yes," what specific, identifiable, sufficient, and quantifiable benefits from the community solar subscription are being passed through to the tenants?

Additionally, the account holder of the master meter must attach a signed affidavit that the specific, identifiable, sufficient, and quantifiable benefits from the community solar subscription will be passed through to the tenants.

If "No," please be aware that, if, at any time during the operating life of the community solar project the account holder of a master meter wishes to subscribe to the community solar project on behalf of its tenants, it must submit to the Board a signed affidavit that the specific, identifiable, sufficient, and quantifiable benefits from the community solar subscription will be passed through to its tenants.

9. The geographic restriction for distance between project site and subscribers is: (select one)
 No geographic restriction: whole EDC service territory
 Same county OR same county and adjacent counties
 Same municipality OR same municipality and adjacent municipalities

Note: The geographic restriction selected here will apply for the lifetime of the project, barring special dispensation from the Board, pursuant to N.J.A.C. 14:8-9.5(a).



10. Product Offering: (The Applicant must also complete and attach one or more product offering form(s) found in Appendix A. See Appendix A for exemptions.)

The subscription proposed offers guaranteed or fixed savings to subscribers Yes No

If "Yes," the guaranteed or fixed savings are offered as:

- A percentage saving on the customer's annual electric utility bill
- A percentage saving on the customer's community solar bill credit
- Other: _____

If "Yes," the proposed savings represent:

- 0% - 5% of the customer's annual electric utility bill or bill credit
- 5% - 10% of the customer's annual electric utility bill or bill credit
- 10% - 20% of the customer's annual electric utility bill or bill credit
- over 20% of the customer's annual electric utility bill or bill credit

The subscription proposed offers subscribers ownership or a pathway to ownership of a share of the community solar facility Yes No

If "Yes," include proof of a pathway to ownership of a share of the community solar facility offered to the subscribers in Appendix A.

11. The list of approved community solar projects will be published on the Board's website. Additionally, subscriber organizations have the option of indicating, on this list, that the project is currently seeking subscribers.

If this project is approved, the Board should indicate on its website that the project is currently seeking subscribers Yes No

If "Yes," the contact information indicated on the Board's website should read:

Company/Entity Name: NextGrid Inc Contact Name: Michael Marcotte
 Daytime Phone: [REDACTED] Email: [REDACTED]

Note: it is the responsibility of the project's subscriber organization to notify the Board if/when the project is no longer seeking subscribers, and request that the Board remove the above information on its website.

X. Community Engagement

1. The proposed community solar project is being developed by or in collaboration* with the municipality in which the project is located Yes No

If "Yes," explain how and attach a letter of support from the municipality in which the project is located.

*Collaboration with the municipality should include, at minimum, one or more meetings with relevant municipal authorities and clear evidence of municipal involvement and approval of the design, development, or operation of the proposed community solar project.



We have been working with Lakewood organization on direct outreach, offers and meetings. So far we have contacted 24 organizations to let them know about the upcoming programs. Please see email correspondence with the township

2. The proposed community solar project is being developed in collaboration* with one or more local community organization(s) Yes No

If "Yes," explain how and attach a letter of support from the local community organization(s).

*Collaboration with a local community organization should include, at minimum, one or more meetings with the relevant local community organization(s) and clear evidence of the local community organization's involvement and approval of the design, development, or operation of the proposed community solar project.

So far we have contacted 24 organizations to let them know about the upcoming programs. Please see email correspondence with the township

3. The proposed community solar project was developed, at least in part, through a community consultative process* Yes No

If "Yes," please describe the consultative process.

*A community consultative process should include, at minimum, one or more opportunities for public intervention and outreach to the municipality and/or local community organizations.

Please see attached email chains.

XI. Project Cost

1. Provide the following cost estimates and attach substantiating evidence in the form of charts and/or spreadsheet models:

Applicants are expected to provide a good faith estimate of costs associated with the proposed community solar project, as they are known at the time the Application is filed with the Board. This information will not be used in the evaluation of the proposed community solar project.

Net Installed Cost (in \$)	██████████
Net Installed Cost (in \$/Watt)	██████
Initial Customer Acquisition Cost (in \$/Watt)	███
Annual Customer Churn Rate (in %)	███



Annual Operating Expenses (in c/kWh)	■
LCOE (in c/kWh)	■

2. Pursuant to N.J.A.C. 14:8-9.7(q), "community solar projects shall be eligible to apply, via a one-time election prior to the delivery of any energy from the facility, for SRECs or Class I RECs, as applicable, or to any subsequent compensations as determined by the Board pursuant to the Clean Energy Act."

For indicative purposes only, please indicate all local, state and federal tax incentives which will be applied to if the proposed community solar project is approved for participation in the Community Solar Energy Pilot Program:

Investment Tax Credit (ITC), MACRS Depreciation, Interest Expense

XII. Other Benefits

1. The proposed community solar facility is paired with another distributed energy resource:
 - a. Micro-grid project Yes No
 - b. Storage Yes No
 - c. Other (*identify*): _____ Yes No

2. The proposed community solar facility provides grid benefits (e.g. congestion reduction) Yes No

If "Yes" to any, please explain how and provide supporting documents.

<https://www.nrel.gov/docs/fy10osti/45653.pdf>

4. The proposed community solar project will create temporary or permanent jobs in New Jersey Yes No
 If "Yes," estimated number of temporary jobs created in New Jersey: 25
 If "Yes," estimated number of permanent jobs created in New Jersey: 4

5. The proposed community solar project will provide job training opportunities for local solar trainees Yes No
 If "Yes," will the job training be provided through a registered apprenticeship? Yes No



If "Yes," identify the entity or entities through which job training is or will be organized (e.g. New Jersey GAINS program, partnership with local school):
GRID Alternatives Training Programs

XIII. Special Authorizations and Exemptions

1. Is the proposed community solar project co-located with another community solar facility (as defined at N.J.A.C. 14:8-9.2)? Yes No

If "Yes," please explain why the co-location can be approved by the Board, consistent with the provisions at N.J.A.C. 14:8-9.

2. Does this project seek an exemption from the 10-subscriber minimum? Yes No

If "Yes," please demonstrate below (and attach supporting documents as relevant):

- a. That the project is sited on the property of a multi-family building.
- b. That the project will provide specific, identifiable, and quantifiable benefits to the households residing in said multi-family building.

3. Specific sections throughout the Application Form are identified as optional only if: 1) the Applicant is a government entity (municipal, county, or state), and 2) the community solar developer will be selected by the Applicant via a RFP, RFQ, or other bidding process. Has the Applicant left those specific sections blank? Yes No

If "Yes," attach a letter describing the proposed bidding process. The Applicant must further commit to issuing said RFP, RFQ, or other bidding process within 90 days of the proposed project being approved by the Board for participation in the Community Solar Energy Pilot Program. The Applicant will be required to provide the information contained in those optional sections to the Board once it becomes known.

4. Has the proposed community solar project received, in part or in whole, a subsection (t) conditional certification from the Board prior to February 19, 2019? Yes No

If "Yes," the project may apply to participate in the Community Solar Energy Pilot Program if it commits to withdrawing the applicable subsection (t) conditional certification immediately if it is approved by the Board for participation in the Community Solar Energy Pilot Program. Attach a signed affidavit that the Applicant will immediately withdraw the applicable subsection (t)



conditional certification if the proposed project is approved by the Board for participation in the Community Solar Energy Pilot Program.





Section C: Certifications

Instructions: Original signatures on all certifications are required. All certifications in this section must be notarized.

Applicant Certification

The undersigned warrants, certifies, and represents that:

- 1) I, Debra Entero (name) am the Authorized Agent (title) of the Applicant IP Solar NJ (name) and have been authorized to file this Applicant Certification on behalf of my organization; and
- 2) The information provided in this Application package has been personally examined, is true, accurate, complete, and correct to the best of the undersigned's knowledge, based on personal knowledge or on inquiry of individuals with such knowledge; and
- 3) The community solar facility proposed in the Application will be constructed, installed, and operated as described in the Application and in accordance with all Board rules and applicable laws; and
- 4) The system proposed in the Application will be constructed, installed, and operated in accordance with all Board policies and procedures for the SREC Registration Program or subsequent revision to the SREC Registration Program, if applicable; and
- 5) My organization understands that certain information in this Application is subject to disclosure under the Open Public Records Act, N.J.S.A. 47-1A-1 et seq., and that sensitive and trade secret information that they wish to keep confidential should be submitted in accordance with the confidentiality procedures set forth in N.J.A.C. 14:1-12.3.; and
- 6) My organization acknowledges that **submission of false information may be grounds for denial of this Application, and if any of the foregoing statements are willfully false, they are subject to punishment to the full extent of the law, including the possibility of fine and imprisonment.**

Signature: [Handwritten Signature] Date: 9/5/19

Print Name: Debra Entero
Title: Authorized Agent Company: IP Solar NJ

Signed and sworn to before me on this 5 day of September, 2019

Signature [Handwritten Signature]
Name Deanna Pistola

DeAnna Pistola
NOTARY PUBLIC OF NEW JERSEY
My Commission Expires 4/6/2020

IP SOLAR NJ, LLC 125 KENYON DRIVE



Project Developer Certification

This Certification "Project Developer / Installer" is optional if: 1) the Applicant is a government entity (municipal, county, or state), AND 2) the community solar developer will be selected by the Applicant via a Request for Proposals (RFP), Request for Quotations (RFQ), or other bidding process. In all other cases, this Certification is required.

The undersigned warrants, certifies, and represents that:

- 1) I, GEORGE ST. ONGE (name) am the Project Developer - Agent (title) of the Project Developer NEXT GRID INC. (name) and have been authorized to file this Applicant Certification on behalf of my organization; and
2) The information provided in this Application package has been personally examined, is true, accurate, complete, and correct to the best of the undersigned's knowledge, based on personal knowledge or on inquiry of individuals with such knowledge; and
3) The community solar facility proposed in the Application will be constructed, installed, and operated as described in the Application and in accordance with all Board rules and applicable laws; and
4) The system proposed in the Application will be constructed, installed, and operated in accordance with all Board policies and procedures for the SREC Registration Program or subsequent revision to the SREC Registration Program, if applicable; and
5) My organization understands that certain information in this Application is subject to disclosure under the Open Public Records Act, N.J.S.A. 47-1A-1 et seq., and that sensitive and trade secret information that they wish to keep confidential should be submitted in accordance with the confidentiality procedures set forth in N.J.A.C. 14:1-12.3.; and
6) My organization acknowledges that submission of false information may be grounds for denial of this Application, and if any of the foregoing statements are willfully false, they are subject to punishment to the full extent of the law, including the possibility of fine and imprisonment.

Signature: George St. Onge Date: Sept. 5, 2019
Print Name: GEORGE ST. ONGE
Title: Project Developer - Agent Company: NEXT GRID INC.

Signed and sworn to before me on this 5 day of September, 2019

Signature DeAnna Pistola
Name

DeAnna Pistola
NOTARY PUBLIC OF NEW JERSEY
My Commission Expires 4/6/2020



Project Owner Certification

The undersigned warrants, certifies, and represents that:

- 1) I, GEORGE ST. ONGE (name) am the Project Developer-Agent (title) of the Project Owner NEXT GRID INC. (name) and have been authorized to file this Applicant Certification on behalf of my organization; and
2) The information provided in this Application package has been personally examined, is true, accurate, complete, and correct to the best of the undersigned's knowledge, based on personal knowledge or on inquiry of individuals with such knowledge; and
3) The community solar facility proposed in the Application will be constructed, installed, and operated as described in the Application and in accordance with all Board rules and applicable laws; and
4) The system proposed in the Application will be constructed, installed, and operated in accordance with all Board policies and procedures for the SREC Registration Program or subsequent revision to the SREC Registration Program, if applicable; and
5) My organization understands that certain information in this Application is subject to disclosure under the Open Public Records Act, N.J.S.A. 47-1A-1 et seq., and that sensitive and trade secret information that they wish to keep confidential should be submitted in accordance with the confidentiality procedures set forth in N.J.A.C. 14:1-12.3.; and
6) My organization acknowledges that submission of false information may be grounds for denial of this Application, and if any of the foregoing statements are willfully false, they are subject to punishment to the full extent of the law, including the possibility of fine and imprisonment.

Signature: George St. Onge Date: Sept. 5, 2019
Print Name: GEORGE ST. ONGE
Title: Project Developer-Agent Company: NEXT GRID INC.

Signed and sworn to before me on this 5 day of September, 2019

Signature: DeAnna Pistola
Name

DeAnna Pistola
NOTARY PUBLIC OF NEW JERSEY
My Commission Expires 4/6/2020



Property Owner Certification

The undersigned warrants, certifies, and represents that:

- 1) I, IP Solar NJ (name) am the Authorized Agent (title) of the Property Kenon 125 LLC (name) and have been authorized to file this Applicant Certification on behalf of my organization; and
2) The information provided in this Application package pertaining to siting and location of the proposed community solar project has been personally examined, is true, accurate, complete, and correct to the best of the undersigned's knowledge, based on personal knowledge or on inquiry of individuals with such knowledge; and
3) My organization or I understand that certain information in this Application is subject to disclosure under the Open Public Records Act, N.J.S.A. 47-1A-1 et seq., and that sensitive and trade secret information that they wish to keep confidential should be submitted in accordance with the confidentiality procedures set forth in N.J.A.C. 14:1-12.3.; and
4) My organization acknowledges that submission of false information may be grounds for denial of this Application, and if any of the foregoing statements are willfully false, they are subject to punishment to the full extent of the law, including the possibility of fine and imprisonment.

Signature: [Handwritten Signature] Date: 9/5/19

Print Name: Debra Einhorn Title: Authorized Agent Company: IP Solar NJ

Signed and sworn to before me on this 5 day of September 2019

[Handwritten Signature]

Signature DeAnna Pistola Name

DeAnna Pistola NOTARY PUBLIC OF NEW JERSEY My Commission Expires 4/6/2020



Section D: Appendix

Appendix A: Product Offering Questionnaire

Complete the following Product Offering Questionnaire. If there are multiple different product offerings for the proposed community solar project, please complete and attach one Product Offering Questionnaire per product offering.

Applicants are expected to provide a good faith description of the product offerings developed for the proposed community solar project, as they are known at the time the Application is filed with the Board. If the proposed project is approved by the Board, the Applicant must notify the Board and receive approval from the Board for any modification or addition to a Product Offering Questionnaire.

Exception: This "Product Offering Questionnaire" is optional if: 1) the Applicant is a government entity (municipal, county, or state), AND 2) the community solar developer will be selected by the Applicant via a Request for Proposals (RFP), Request for Quotations (RFQ), or other bidding process.

This Questionnaire is Product Offering number 1 of 1 (total number of product offerings).

1. Community Solar Subscription Type (examples: kilowatt hours per year, kilowatt size, percentage of community solar facility's nameplate capacity, percentage of subscriber's historical usage, percentage of subscriber's actual usage):
bill credits based on system output

2. Community Solar Subscription Price: (check all that apply)
 Fixed price per month
 Variable price per month, variation based on: System Out put
 The subscription price has an escalator of _____ % every _____ (interval)

3. Contract term (length): _____ months, or 1 years OR month-to-month

4. Fees
 Sign-up fee: _____
 Early Termination or Cancellation fees: _____
 Other fee(s) and frequency: _____

5. Does the subscription guarantee or offer fixed savings or specific, quantifiable economic benefits to the subscriber? Yes No
If "Yes," the savings are guaranteed or fixed:



- As a percentage of monthly utility bill
- As a fixed guaranteed savings compared to average historic bill
- As a fixed percentage of bill credits
- Other: _____

6. Special conditions or considerations:





Appendix B: Required Attachments Checklist

Note that this list is for indicative purposes only. Additional attachments may be required, and are identified throughout this Application Form.

Required Attachments for all Applications	Page	Attached?
Delineated map of the portion of the property on which the community solar facility will be located.	p.7	<input checked="" type="checkbox"/> Yes <input type="checkbox"/> No
For electronic submission only: copy of the delineated map of the portion of the property on which the community solar facility will be located as a PDF and in drawing file format (.dwg) or as a shapefile (.shp).	p.7	<input checked="" type="checkbox"/> Yes <input type="checkbox"/> No
Proof of site control.	p.8	<input checked="" type="checkbox"/> Yes <input type="checkbox"/> No
Copy of the completed Permit Readiness Checklist as it was submitted to NJDEP PCER, if applicable.	p.11	<input type="checkbox"/> Yes <input checked="" type="checkbox"/> No
Proof of a meeting with NJDEP PCER, if applicable.	p.12	<input type="checkbox"/> Yes <input checked="" type="checkbox"/> No
A screenshot of the capacity hosting map at the proposed location, showing the available capacity.	p.12	<input type="checkbox"/> Yes <input type="checkbox"/> No
Substantiating evidence of project cost in the form of charts and/or spreadsheet models.	p.16	<input checked="" type="checkbox"/> Yes <input type="checkbox"/> No
Certifications in Section C.	p.19-23	<input checked="" type="checkbox"/> Yes <input type="checkbox"/> No
Product Offering Questionnaire(s).	p.24	<input checked="" type="checkbox"/> Yes <input type="checkbox"/> No

Required Attachments for Exemptions	Page	Attached?
The Applicant is a government entity (municipal, county, or state), and the community solar developer will be selected by the Applicant via a Request for Proposals (RFP), Request for Quotations (RFQ), or other bidding process: ⇒ Attach a letter from the Applicant describing the bidding process	p.6, p.19	<input type="checkbox"/> Yes <input checked="" type="checkbox"/> No
The proposed community solar project is located, in part or in whole, on Green Acres preserved open space or on land owned by NJDEP. ⇒ Attach special authorization from NJDEP for the site to host a community solar facility.	p.8	<input type="checkbox"/> Yes <input checked="" type="checkbox"/> No
The proposed community solar project has received, in part or in whole, a subsection (t) conditional certification from the Board prior to February 19, 2019. ⇒ Attach a signed affidavit that the Applicant will immediately withdraw the applicable subsection (t) conditional certification if the proposed project is approved by the Board for participation in the Community Solar Energy Pilot Program.	p. 19	<input type="checkbox"/> Yes <input checked="" type="checkbox"/> No



Appendix C: Evaluation Criteria

The Evaluation Criteria chart below lists the various categories that the Board will consider in evaluating project Applications. Projects must score a minimum 30 points total in order to be considered for participation in the Community Solar Energy Pilot Program. Projects that score above 30 points will be awarded program capacity in order, starting with the highest-scoring project and proceeding to the lowest-scoring project.

Evaluation Criteria	Max. Points
Low- and Moderate-Income and Environmental Justice Inclusion Higher preference: LMI project	30
Siting Higher preference: landfills, brownfields, areas of historic fill, rooftops, parking lots, parking decks Medium preference: canopies over impervious surfaces (e.g. walkway), areas designated in need of redevelopment No Points: preserved lands, wetlands, forested areas, farmland Bonus points for: landscaping, land enhancement, pollination support, stormwater management, soil conservation	20 Max. possible bonus points: 5
Product Offering Higher preference: guaranteed savings >10%, flexible terms* Medium preference: guaranteed savings >5% No Points: no guaranteed savings, no flexible terms* *Flexible terms may include: no cancellation fee, short-term contract	15
Community and Environmental Justice Engagement Higher preference: partnership with municipality, partnership with local community organization(s), partnership with affordable housing provider Medium preference: letter of support from municipality, project owner is a government and/or public and/or quasi-public entity, project owner is an affordable housing developer	10
Subscribers Higher preference: more than 51% project capacity is allocated to residential subscribers	10
Other Benefits Higher preference: Provides local jobs/job training, demonstrates co-benefits (e.g. paired with storage, micro-grid project, energy audit, EE measures)	10
Geographic Limit within EDC service territory Higher preference: municipality/adjacent municipality Medium preference: county/adjacent county No Points: any geographic location within the EDC service territory.	5

PROPOSED SOLAR PROJECT

125 KENYON DRIVE
LAKEWOOD, NJ 08701

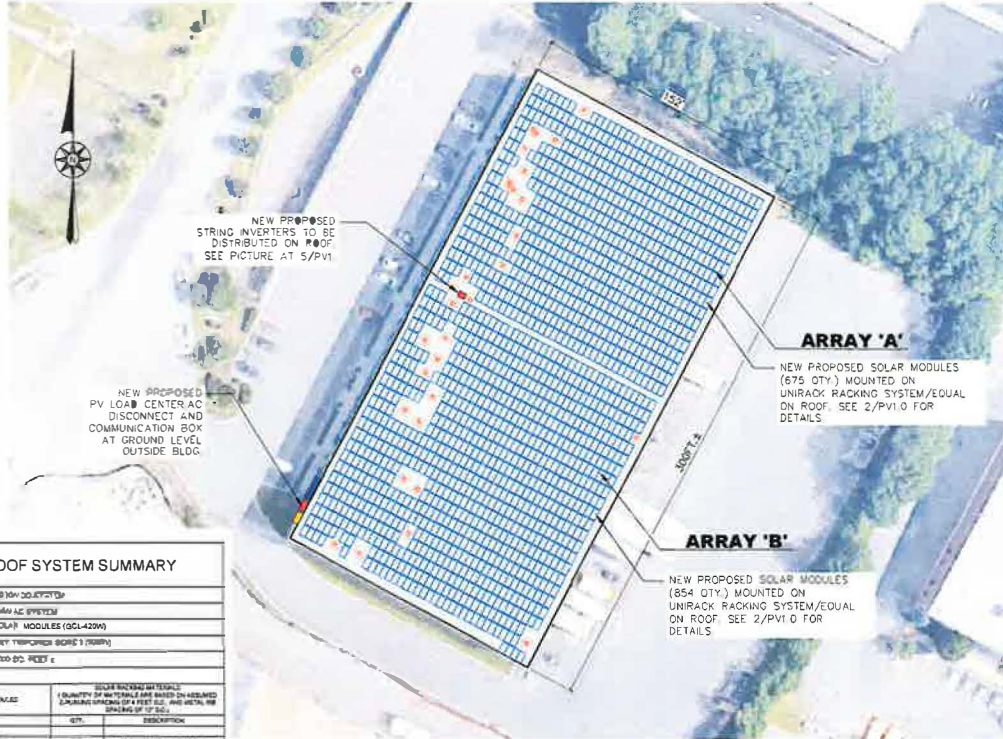

5 SMA STRING INVERTER
PV1.0 SCALE: 1/8\"/>

NOTE:
THIS PICTURE IS SMA INVERTER FOR VISUAL AID PURPOSES ONLY. FINAL DESIGN IS SUBJECT TO P.E. REVIEW AND APPROVAL.

PROPOSED COMMERCIAL SOLAR ROOF SYSTEM SUMMARY																																				
SYSTEM SIZE	642.2KW DC (24.577KW AC)																																			
TOTAL QTY. OF SOLAR MODULES	1,239 QTY. (600 SOLAR MODULES (DC1420W))																																			
TOTAL QTY. OF INVERTERS	10 QTY. SMA SUNNY TRIPODER (S01517000P)																																			
TOTAL AREA OF PV ARRAY	42,100 SQ. FEET ±																																			
<table border="1"> <thead> <tr> <th>ARRAY</th> <th>MODULE QTY.</th> <th>DC WATT</th> <th>AC WATT</th> <th>AREA</th> <th>SOLAR MODULES</th> <th>SOLAR RACKING MATERIALS</th> </tr> <tr> <td colspan="6"></td> <td>(QUANTITY OF MATERIALS ARE BASED ON ASSUMED 2" RAISE SPACING OF 4 FEET B.C. AND METAL ROOF SPACING OF 2 FEET)</td> </tr> <tr> <td colspan="6"></td> <td>QTY. DESCRIPTION</td> </tr> </thead> <tbody> <tr> <td>A</td> <td>475</td> <td>240,000W</td> <td>117</td> <td>27,500 SQ. FT. ±</td> <td>DC-1420W</td> <td>120 2" RIBS/2X12" UNIRAC RAIL ALUMINUM L-FOOT</td> </tr> <tr> <td>B</td> <td>764</td> <td>402,200W</td> <td>117</td> <td>14,600 SQ. FT. ±</td> <td>DC-1420W</td> <td>120 2" RIBS/2X12" UNIRAC RAIL ALUMINUM L-FOOT</td> </tr> </tbody> </table>		ARRAY	MODULE QTY.	DC WATT	AC WATT	AREA	SOLAR MODULES	SOLAR RACKING MATERIALS							(QUANTITY OF MATERIALS ARE BASED ON ASSUMED 2" RAISE SPACING OF 4 FEET B.C. AND METAL ROOF SPACING OF 2 FEET)							QTY. DESCRIPTION	A	475	240,000W	117	27,500 SQ. FT. ±	DC-1420W	120 2" RIBS/2X12" UNIRAC RAIL ALUMINUM L-FOOT	B	764	402,200W	117	14,600 SQ. FT. ±	DC-1420W	120 2" RIBS/2X12" UNIRAC RAIL ALUMINUM L-FOOT
ARRAY	MODULE QTY.	DC WATT	AC WATT	AREA	SOLAR MODULES	SOLAR RACKING MATERIALS																														
						(QUANTITY OF MATERIALS ARE BASED ON ASSUMED 2" RAISE SPACING OF 4 FEET B.C. AND METAL ROOF SPACING OF 2 FEET)																														
						QTY. DESCRIPTION																														
A	475	240,000W	117	27,500 SQ. FT. ±	DC-1420W	120 2" RIBS/2X12" UNIRAC RAIL ALUMINUM L-FOOT																														
B	764	402,200W	117	14,600 SQ. FT. ±	DC-1420W	120 2" RIBS/2X12" UNIRAC RAIL ALUMINUM L-FOOT																														

1 OVER-ALL SITE PLAN & PV ROOF ARRAY LAYOUT 642.2KWDC
PV1.0 SCALE: 1" = 30' ±

- NOTES:**
- PROPOSED SOLAR RACKING SYSTEM AND PV EQUIPMENT SPECIFICATIONS ARE SUBJECT TO CHANGE AND MUST BE REVIEWED AND APPROVED BY THE PROFESSIONAL ENGINEERS. QUANTITIES ARE ESTIMATES. NOT FINAL.
 - ROOF IS SUBJECT TO SITE SURVEY TO VERIFY DIMENSIONS/RTU LOCATIONS, EXISTING ROOF 3" DRIP AND OBSTRUCTIONS. EXISTING RTU TO REMAIN UNLESS OTHERWISE NOTED.
 - ELECTRICAL SURVEY SHOULD BE CONDUCTED TO VERIFY EXISTING ELECTRICAL CONDITIONS.
 - MINIMUM SETBACK FROM EDGE OF ROOF IS 4 FEET AND 3 FEET FROM HVAC/BIG RTUs.

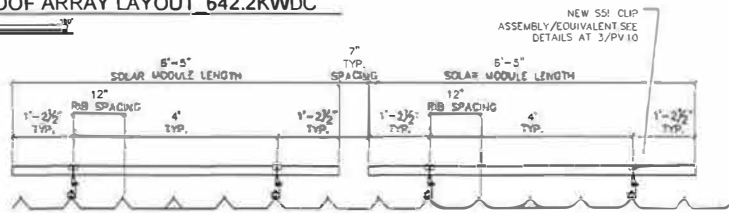

2 UNIRAC RACKING SYSTEM
PV1.0 SCALE: 1/8\"/>

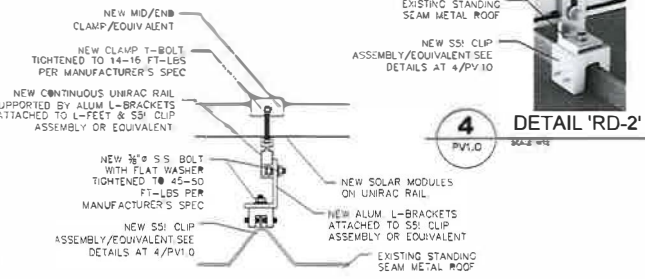

3 DETAIL 'RD-1'
PV1.0 SCALE: 1/8\"/>

4 DETAIL 'RD-2'
PV1.0 SCALE: 1/8\"/>

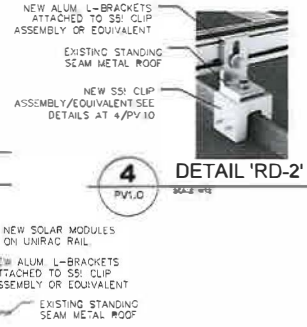

NOT FOR CONSTRUCTION

NextGrid

ENGINEER:

DATE: 2/20/2022

SCALE: 1/8"

DESCRIPTION: PV1.0

PROJECT NAME: ROOFTOP SOLAR PROJECT 125 KENYON DRIVE LAKEWOOD, NJ 08701

DATE: 2/20/2022

SCALE: 1/8"

DESCRIPTION: PV1.0

PROJECT NAME: ROOFTOP SOLAR PROJECT 125 KENYON DRIVE LAKEWOOD, NJ 08701

PV 1.0

Show search results for 125 Ken...

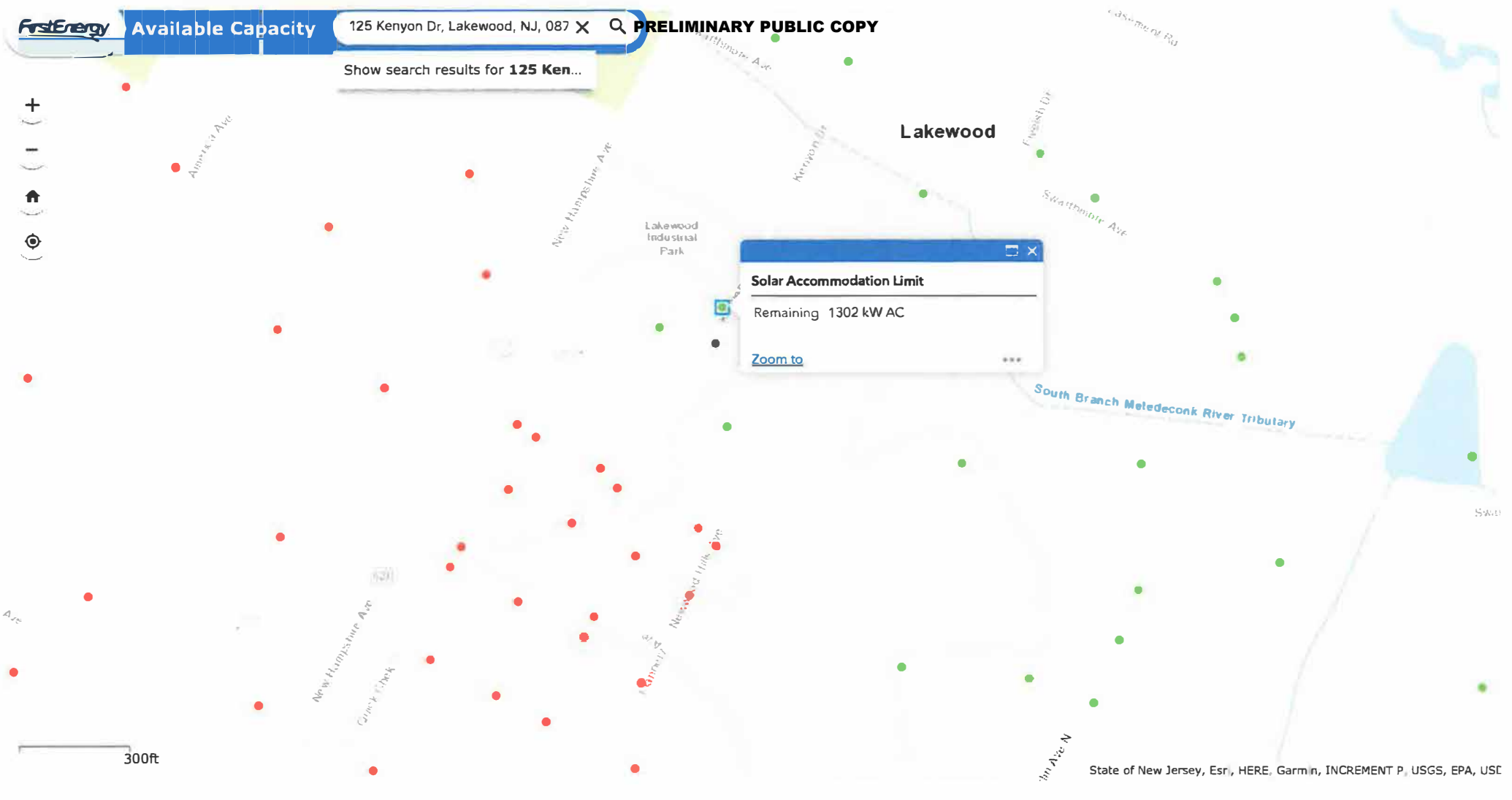

Solar Accommodation Limit

Remaining 1302 kW AC

[Zoom to](#)

Project Details

Project Name
Project Developer NextGrid Inc.
Address



System Details

System Size 642 kW DC
Watts 642,000
EPC Cost \$ per Watt
Cost \$
ITC Eligible Costs \$

All-In Cost \$ per Watt
Total \$
IRR

PPA Economics

PPA Rate Calculation Simple
PPA Initial Rate \$
PPA Annual Escalator
PPA Max Rate? No
PPA Max Rate (if applicable) \$

Incentives

Federal Benefits
Investment Tax Credit 30.00%
Depreciation Treatment 5-yr MACRS
Bonus Depreciation 50%
ITC Basis \$
% Costs Eligible \$/W
% Change to EPC Cost 0%

Investor Economics

Federal Tax Rate 21.0%

Operating Expenses

Annual Expenses	\$	\$/kW
Operations & Maintenance	\$	\$/kW
Insurance	\$	\$/kW
Property Tax or PILOT	\$	\$/kW
Site Lease	\$	\$/kW
Annual Escalator	\$	\$/kW
Project Accounting	\$	\$/kW
Total	\$	\$/kW

Reserves Contribution
Yearly Contribution \$ /kW
Total \$

Initial Production 770,400 kWh / year
Production 1,200 kWp
Production Degradation 0.75% per year
Contract / Service Life 25 years
COD 12/31/2019

PPA Prepayment \$
Buyout Year 0.0

State Benefits
SRECs Available? Yes
SREC Calculation (if applicable) Simple
SREC Value \$ /mWh
Annual Change 10.0 years
Contract Term 196
State Cash Rebate Rate \$ /kW
Calculated Rebate \$
Max Cash Rebate Allowed
State Cash Rebate \$

State Tax Rate 5.0%

Transaction Fees	\$	\$/W
Development Fees - ITC Eligible	\$	\$/W
Interconnection Fees	\$	\$/W
Land Cost	\$	\$/W
Other Expenses - ITC Ineligible	\$	\$/W
Total	\$	\$/W
Total - ITC Eligible	\$	\$/W
Total - ITC Ineligible	\$	\$/W

One-Time Expenses
First Year Variable O&M \$

RESULTS

IRR
Payoff (years)
NPV (@ 0.05 discount rate) \$
Asset Cost Per Watt \$
All-In Cost Per Watt \$

Capital Contribution

ITC Eligible Equity Contribution \$
ITC Ineligible Costs & Fees \$
Initial Reserve Contribution \$
All-In Initial Capital Contribution \$

Debt

Principle None
Term (years)
APR
Annual Payment \$
Average DSCR 0.00
Lowest DSCR 0.00

Production

Initial Production (kWh)
Initial Production (kWp)
Annual Degradation
Initial PPA Rate (\$/kWh)
First Year SREC
Service Life (years)

Revenues

First Year Energy Sales \$
First Year SREC Sales \$
PPA Prepayment \$

All Project First Year Revenues \$
Average Pre-Tax Cash Flow to Equity \$

Incentives

ITC \$
ITC Basis \$
ITC Basis (\$/W) \$
Depreciation Income \$
Depreciation Treatment 5-yr MACRS
Bonus Depreciation 50%
State Cash Rebate \$
All Incentives \$
All Incentives % of Capital Contributions
All Incentives % of Claimed Value

Developer Fee Calculator

Costs
Costs (Land)
Development \$

Investor Economics

All-In Initial Capital
(Less) Incentives
Net Cash Investment
Average Annual Pre-Tax Cash To
Average Annual Cash on Cash Re

PRELIMINARY PUBLIC COPY



Patrick Donnelly
Municipal Manager

P 732.364.2500 x5200
F 732.994.4568
pdonnelly@lakewoodnj.gov
231 Third Street | Lakewood, NJ 08701



Name: Scott Pappas
Title: Asst. Director
Ext. 112

317 Sampson Avenue
P.O. Box 1599
Lakewood, NJ 08701

Tel. (732) 364-1300
Fax: (732) 367-3299
lhanj@optonline.net

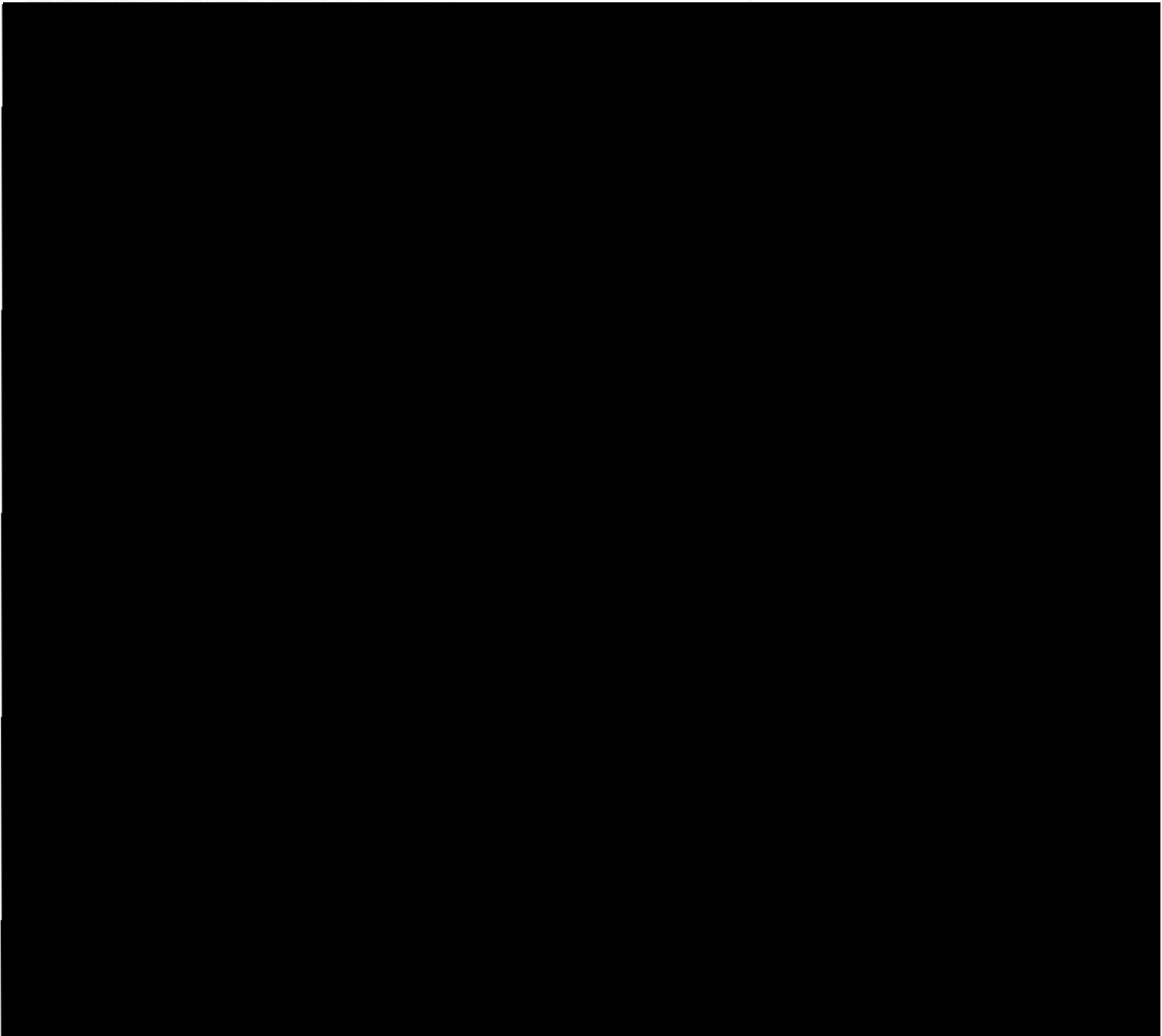

[REDACTED]

[REDACTED]

[REDACTED]

[REDACTED]

[REDACTED]

[REDACTED]

[REDACTED]

[REDACTED]

[REDACTED]

[REDACTED]

[REDACTED]

[REDACTED]

[REDACTED]

[REDACTED]

[REDACTED]

[REDACTED]

[REDACTED]

[REDACTED]

[REDACTED]

[REDACTED]

[REDACTED]

[REDACTED]

[REDACTED]

[REDACTED]

[REDACTED]

[REDACTED]

[REDACTED]

[REDACTED]

[REDACTED]

[REDACTED]

[REDACTED]

[REDACTED]

[REDACTED]

[REDACTED]

[REDACTED]

[REDACTED]

[REDACTED]

AGENT AGREEMENT

THIS AGENT AGREEMENT (“Agreement”) is made as of the 21st day of August 2019, by and between OBERLIN 170 LLC, OBERLIN CENTER LLC, KENYON 125 LLC, RUTGERS 1970 LLC, AIRPORT 945 LLC, SWARTHMORE 1915 LLC, New Jersey limited liability companies (“Owners”) with a mailing address of 1750 Cedar Bridge Avenue, Lakewood, New Jersey 08701 and IP SOLAR NJ, a New Jersey limited liability company (“Manager”), with a mailing address of 1750 Cedar Bridge Avenue, Lakewood, New Jersey 08701.

RECITALS:

WHEREAS the Owners desire to appoint and engage Manager as its lawful agent and representative to perform the services described hereunder;

WHEREAS the Manager agrees to accept such appointment and to represent the Owners and perform such Services in the territory described herein, under the terms and conditions in this Agreement;

NOW, THEREFORE, in consideration of the promises and covenants contained herein, the Parties hereby agree as follows:

TERMS:

1. **Duties of Manager.** Subject to the provisions hereof and during the term hereof, Owners hereby appoints Manager as exclusive manager of the roof of the Properties and Manager hereby accepts appointment as the manager of the roof of the Properties. Manager shall have site control of the building roof, and will have the ability to enter into negotiations and contracts for solar. Manager agrees to manage the roof in a professional, competent manner. Without limiting the generality of the foregoing, Manager agrees to, and is hereby granted the authority to perform these duties.

2. **Compliance.**

(a) **Legal and Insurance Requirements.** Manager agrees to comply with and abide by all laws, rules, regulations, requirements, orders, notices, determinations and ordinances of any federal, state or municipal authority; and the requirements of any insurance companies covering any of the risks against which the Property is insured.

(b) **No Discrimination.** Neither Manager nor anyone authorized to act for Manager in the rental, sale, the provision of services, or in any other manner shall discriminate against any person on the grounds of race, color, creed, religion, handicap, sex or national origin, and Manager hereby agrees to comply with all laws, regulations and ordinances pertaining thereto.

3. **Term of Agreement.** This Agreement shall become effective upon execution by both Owners and Manager (the “Effective Date”), and shall remain in effect until (i) title to the Properties has been conveyed to new Owners; or (ii) Manager’s default under this Agreement, limited to misappropriation of funds, gross negligence and/or fraud; or (iii) both parties agree to terminate this Agreement in writing.

(a) **Entire Agreement.** This Agreement is the entire agreement between the parties with respect to the subject matter hereof, and no alteration, modification, or interpretation hereof shall be binding unless in writing and signed by both parties.

(b) **Severability.** If any provision of this Agreement or application to any party or circumstances shall be determined by any court of competent jurisdiction to be invalid and unenforceable to any extent, the remainder of this Agreement or the application of such provision to such person or circumstances, other than those as to which it is so determined invalid or unenforceable, shall not be affected thereby, and each provision hereof shall be valid and shall be enforced to the fullest extent permitted by law.

(c) **Applicable Law.** This Agreement shall be construed and enforced in accordance with the laws of the State in which the Property is located, without regard to conflicts of law provisions thereof.

(d) **Assignability.** Manager may not assign this Agreement without first obtaining Owner's written consent, which consent Owners may withhold in its sole discretion.

(e) **Relationship.** Nothing contained in this Agreement shall be construed to create a relationship of employer and employee between Manager and Owners, it being the intent of the parties hereto that the relationship created hereby is solely that of an independent contractor. Nothing contained herein shall be deemed to constitute Owners and Manager as partners or joint ventures.

(f) **Successors Bound.** This Agreement shall be binding upon and inure to the benefit of the parties and their permitted assigns.

(g) **Further Acts.** Each party, upon the request of the other, agrees to perform such further acts and to execute and deliver such other documents as are reasonably necessary to carry out the provisions of, and the transactions contemplated by, this Agreement.

(h) **Third Parties.** This Agreement shall not confer in favor of any third parties any rights whatsoever as third-party beneficiaries, except to rights conferred to Lender pursuant to the terms and conditions of a certain Assignment and Subordination of Management Agreement entered into by and between Owners and Manager, in favor of Investors Bank.

(i) **Counterparts and Facsimile Signatures.** This Agreement may be executed in one or more counterparts, each of which shall constitute an original, but all of which taken together shall constitute one and the same documents. The signatures on this Agreement may be delivered with facsimile copies, which shall be as effective as if original signatures were delivered.

(j) **Interpretation.** No provision of this Agreement is to be interpreted for or against either party because that party or that party's legal representative or counsel drafted such provision.

IN WITNESS WHEREOF, Owners and Manager have executed this Agreement as of the date set forth above.

OWNERS:

OBERLIN 170 LLC, OBERLIN 150 LLC,
KENYON 125 LLC, RUTGERS 1970 LLC,
AIRPORT 945 LLC, SWARTHMORE 1915
LLC

By: OBERLIN 170 LLC,
a New Jersey limited liability
company

By: 
Linda Halpern,
Managing Member

By: OBERLIN CENTER LLC,
a New Jersey limited liability
company

By: 
Linda Halpern,
Managing Member

By: KENYON 125 LLC,
a New Jersey limited liability
company

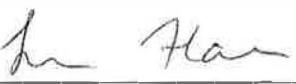
By: 
Linda Halpern,
Managing Member

By: RUTGERS 1970 LLC,
a New Jersey limited liability
company

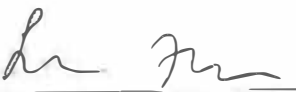
By: 
Linda Halpern,
Managing Member

By: SWARTHMORE 1915 LLC,
a New Jersey limited liability
company

By: 
Linda Halpern,
Managing Member

By: OBERLIN 175 LLC,
a New Jersey limited liability
company

By: 
Linda Halpern,
Managing Member

MANAGER:

IP SOLAR NJ, LLC,
a New Jersey limited liability company

By: 
Linda Halpern,
Managing Member

Community Solar - Indication of Interest – Community Organizations

Next Grid Inc, a solar development and finance company, will be building solar projects in Lakewood NJ to participate in the “new” New Jersey Community Solar program.

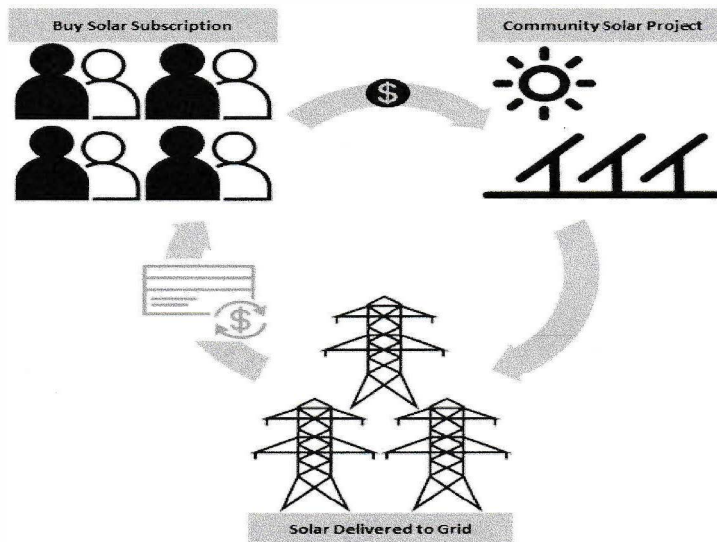

Subscribers to the projects will get a 10 to 20% discount on their JCPL electricity accounts.

There will be no cost to subscribe to Next Grid Community Solar projects. Low and moderate income subscribers will be given preference in the NJBPU evaluation of the solar projects as this has been an underserved segment of New Jersey’s population due to cost.

If Next Grid Inc project applications are accepted by the NJ Board of Public Utilities (NJBPU) then there will be approximately $10 \times 600 \text{ KW} \times 1.2 = 7,200,000 \text{ kWh}$ available yearly to subscribers. If each subscriber uses an average of 7,200 kWh annually then Next Grid subscriber organization will be seeking 1,000 subscribers. The subscriber organization will handle all the paperwork including kWh credits to the subscribers’ JCPL account and billing at the discounted price.

If you would like your community organization to be contacted so that your members can “subscribe” to one of Next Grid’s Community Solar projects please fill in the information below:

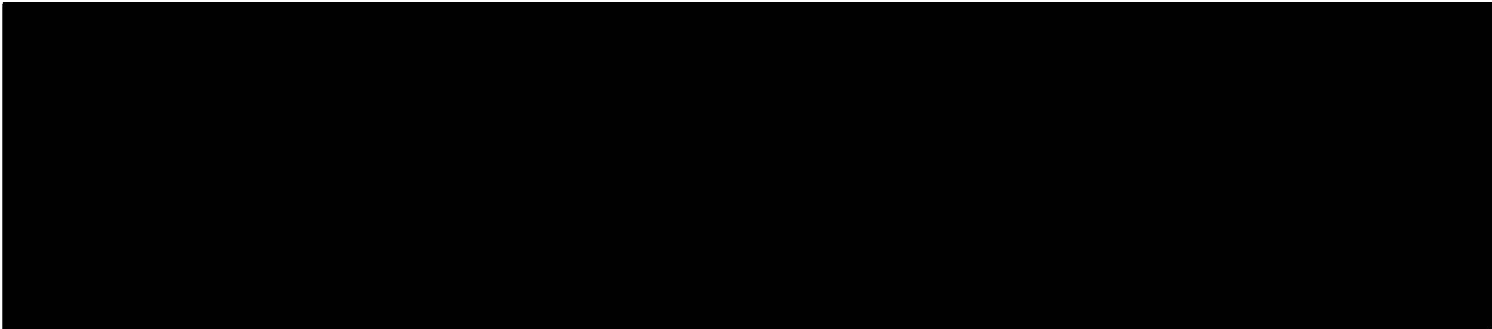

Contact: [REDACTED] [REDACTED] [REDACTED]

Lakewood

Continued from Page 1A

The professional assessment was sought by Lakewood Neighbors, an organization of community leaders who formed in late 2017 seeking to promote positive news coverage and solve community problems. The leaders of Lakewood Neighbors will now decide whether to implement any of the four recommendations from Smith's team.

Lakewood is New Jersey's fastest-growing township, largely because of its increasing number of Orthodox Jewish residents.

The township's transformation from rural resort destination to urban area has been anything but smooth, and neighboring townships have ended up in court over measures some say are thinly-veiled attempts to keep Orthodox Jews from moving in. There are widespread concerns of over-development and ubiquitous anti-Semitism.

Even the mediators' efforts to understand the division were stymied by a culture of anti-Semitism and lack of cooperation, symbolizing soaring barriers to overcome on the path forward.

The assessment laments being unable to interview elected and municipal leaders from townships around Lakewood and several religious leaders. The individuals who did not participate are not named in the report.

"We think that these and other missing perspectives must be engaged if and when specific collaborative processes are designed and implemented," the report reads.

Mediators invited 160 people to do interviews; 90 came. Of the people interviewed, about a dozen were public officials, and predominantly from Lakewood. At least half of the interviewees were Orthodox Jews.

The resulting report summarizes

PRELIMINARY PUBLIC COPY

their perceptions of community problems into three themes:

■ **Bias:** Bias against Orthodox Jews is present, but also exists to a lesser degree within the Orthodox community. Misinformation, misunderstanding and misconceptions create a lack of trust among residents.

■ **Impact of change:** Population and density changes have caused negative impacts, and prompted sometimes "hostile reception" toward Orthodox Jews moving into neighborhoods.

■ **Land use:** "The problems of traffic were mentioned by almost all interviewees," the report says. While concerns are ongoing in Lakewood, most interviewees said neighboring towns were a key place to focus.

"This is a two-way street," Smith said. "We heard from Orthodox and non-Orthodox about concerns about all three of these things."

What's needed?

The report suggests four ways to move forward. Those are:

■ **Refine Lakewood Neighbors** with a clear purpose and structure; expand representation to members of neighboring towns and additional faith and community leaders; and increase transparency of the group.

■ **Promote relationship-building groups** that already exist, and identify and target segments of the community not already being served by those programs.

■ **Develop a shared "community coexistence action plan,"** voluntary agreements for citizens dedicated to "neighborly coexistence, as opposed to seeking changes to township rules or regulations."

■ **Take a regional approach to land use,** infrastructure, transportation, zoning, housing and schools by convening officials and community leaders.

Soon the core group behind Lake-



Homes line Prospect Avenue in Lakewood, where mediators are calling for increased collaboration. THOMAS P. COSTELLO AND MIKE DAVIS/ASBURY PARK PRESS

wood Neighbors will gather to decide whether to implement recommendations in the report and fundraise for those efforts, according to Norris Clark, a public relations professional working for Lakewood Neighbors.

✱ The core group includes Rabbi Aaron Kotler, president of Lakewood's Beth Medrash Govoha; Georgian Court University President Joseph R. Marbach; Lakewood Board of Education member Ada Gonzalez; Lakewood Mayor Raymond Coles; Joe Buckelew, a steady face in county Republican politics, former Lakewood mayor and chairman of insurance broker Conner Strong & Buckelew, which is now at the center of an agenda-stalling controversy over tax incentives in Trenton; David Friedman, chief executive of the Lakewood Resource and Referral Center; and Mike McNeil, president of housing advocacy program Solutions to End Poverty Soon.

Clark and the Consensus Building In-

stitute were hired by the Lakewood Resource and Referral Center, a social services organization associated with Beth Medrash Govoha, the largest Talmudic college in the country. A group of Orthodox Jewish businessmen paid for the assessment, which cost about \$35,000, according to Clark.

But the assessment's recommendations are guidelines anyone can champion and pursue, Smith said.

"There's the opportunity for anyone who is interested to run with any piece of this," she said. "We know there are collaborative groups that already exist in Toms River, for example, there may be pieces of this that they may want to take up."

Stacey Barchenger writes about Lakewood, New Jersey's fastest-growing municipality. She is interested in how that rapid change impacts local residents. Contact her @sbarchenger; 732-427-0114; sbarchenger@gannettnj.com.

ASBURY PARK PRESS

Community Solar - Indication of Interest – Community Organizations

Next Grid Inc, a solar development and finance company, will be building solar projects in Lakewood NJ to participate in the “new” New Jersey Community Solar program.

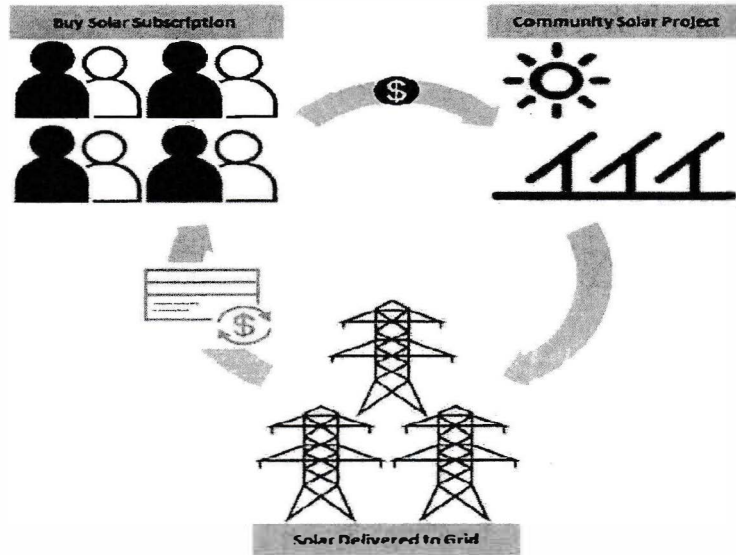

Subscribers to the projects will get a 10 to 20% discount on their JCPL electricity accounts.

There will be no cost to subscribe to Next Grid Community Solar projects. Low and moderate income subscribers will be given preference in the NJBPU evaluation of the solar projects as this has been an underserved segment of New Jersey’s population due to cost.

If Next Grid Inc project applications are accepted by the NJ Board of Public Utilities (NJBPU) then there will be approximately $10 \times 600 \text{ KW} \times 1.2 = 7,200,000 \text{ kWh}$ available yearly to subscribers. If each subscriber uses an average of 7,200 kWh annually then Next Grid subscriber organization will be seeking 1,000 subscribers. The subscriber organization will handle all the paperwork including kWh credits to the subscribers’ JCPL account and billing at the discounted price.

If you would like your community organization to be contacted so that your members can “subscribe” to one of Next Grid’s Community Solar projects please fill in the information below:

[Redacted area for contact information]

Contact: [Redacted] [Redacted] [Redacted]

Community Solar - Indication of Interest – Community Organizations

Next Grid Inc, a solar development and finance company, will be building solar projects in Lakewood NJ to participate in the “new” New Jersey Community Solar program.

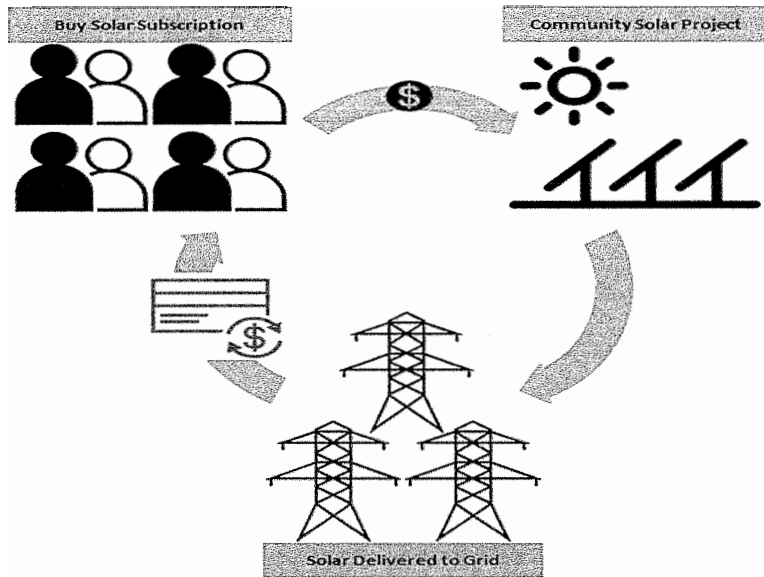

Subscribers to the projects will get a 10 to 20% discount on their JCPL electricity accounts.

There will be no cost to subscribe to Next Grid Community Solar projects. Low and moderate income subscribers will be given preference in the NJBPU evaluation of the solar projects as this has been an underserved segment of New Jersey’s population due to cost.

If Next Grid Inc project applications are accepted by the NJ Board of Public Utilities (NJBPU) then there will be approximately $10 \times 600 \text{ KW} \times 1.2 = 7,200,000 \text{ kWh}$ available yearly to subscribers. If each subscriber uses an average of 7,200 kWh annually then Next Grid subscriber organization will be seeking 1,000 subscribers. The subscriber organization will handle all the paperwork including kWh credits to the subscribers’ JCPL account and billing at the discounted price.

If you would like your community organization to be contacted so that your members can “subscribe” to one of Next Grid’s Community Solar projects please fill in the information below:

Contact: [REDACTED]

PRELIMINARY PUBLIC COPY

Community Solar - Indication of Interest – Community Organizations

Next Grid Inc, a solar development and finance company, will be building solar projects in Lakewood NJ to participate in the “new” New Jersey Community Solar program.

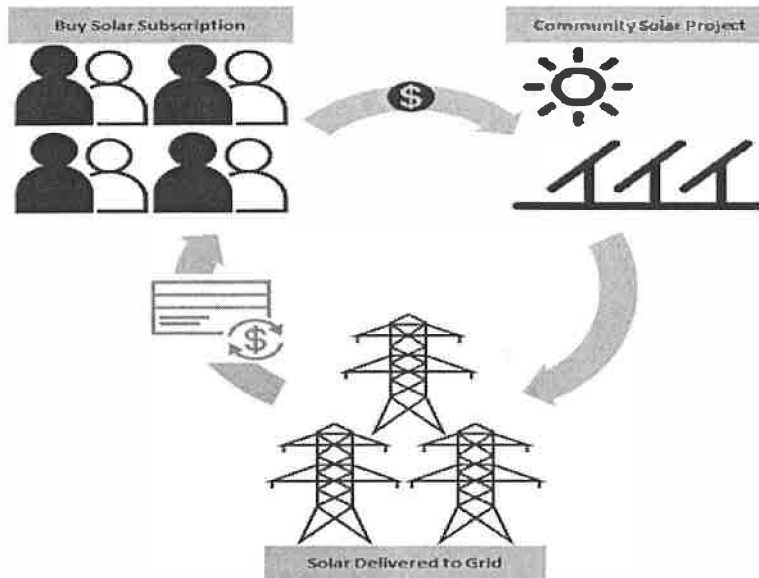

Subscribers to the projects will get a 10 to 20% discount on their JCPL electricity accounts.

There will be no cost to subscribe to Next Grid Community Solar projects. Low and moderate income subscribers will be given preference in the NJBPU evaluation of the solar projects as this has been an underserved segment of New Jersey’s population due to cost.

If Next Grid Inc project applications are accepted by the NJ Board of Public Utilities (NJBPU) then there will be approximately $10 \times 600 \text{ KW} \times 1.2 = 7,200,000 \text{ kWh}$ available yearly to subscribers. If each subscriber uses an average of 7,200 kWh annually then Next Grid subscriber organization will be seeking 1,000 subscribers. The subscriber organization will handle all the paperwork including kWh credits to the subscribers’ JCPL account and billing at the discounted price.

If you would like your community organization to be contacted so that your members can “subscribe” to one of Next Grid’s Community Solar projects please fill in the information below:

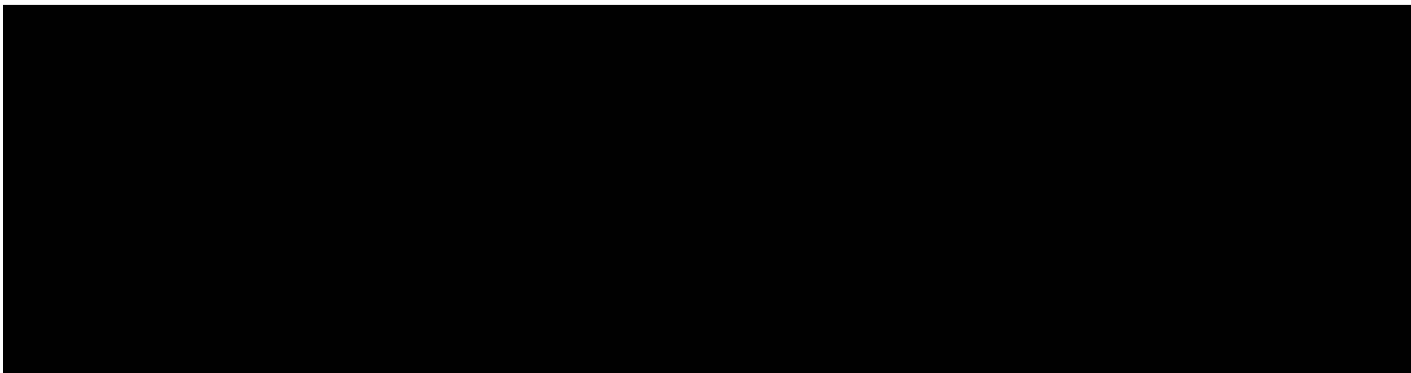

Contact: 